

Varenummer: 2301077731
 Beskrivelse: E+G Håndhjul
 VR.250 FP+IR

Mål

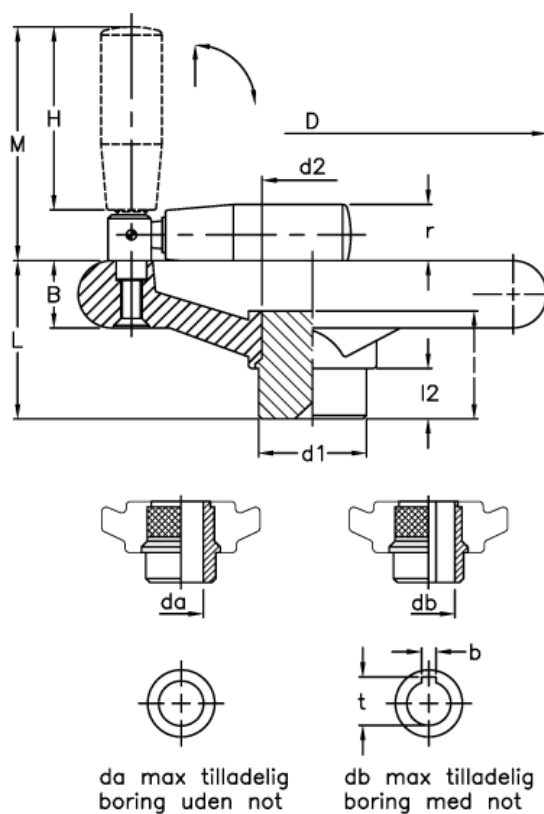

B	= 30	H	= 90	t = 30.3
b	= 8	l	= 44	
C (N*m)	= 405	L	= 66	
D	= 247	L (J)	= 19	
d1	= 49	l2	= 15	
d2	= 38	M	= 113	
da	= 34	r	= 27	
db	= 27	R	= 98	